

# WEBTOOL wire cutter

## - RCV135

Cutting large diameter wire rope and cable in the most hostile environments, under the toughest of conditions and the most demanding of circumstances requires something special.

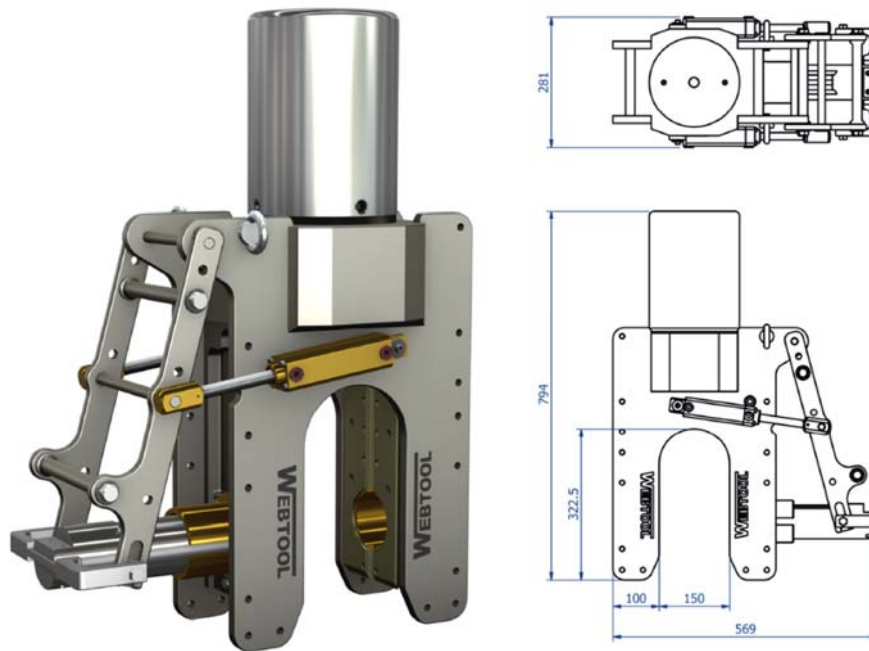

### Main features:

- Proven design.
- Designed to cut wire rope up to 135mm diameter.
- Hydraulically operated anvil for easy ROV deployment.
- Optional intensifier available

Wire diameter:	135mm
Weight:	176kg
Input pressure main cylinder	Max 690 bar
Input pressure anvil	Max 210 bar