

Equipment List

Subsea Baskets

Broad specter of Subsea Baskets.
With variable sizes and payloads.
Single or 4 point lifting opportunities.

Air Lift Bags

In 2014 NOR has invested in open
Air Lift Bags. Ideal for lightening
underwater structures such as
pipes and templates.

Imenco ROV Shackle

We can supply the whole range
of the Imenco ROV Shackle.
From 6,5Te up to 150Te.



Olafur Gislason, Norwegian Offshore Rental AS

Increasing the rental pool range

For the last three years Norwegian Offshore Rental AS has gradually established itself as a major provider of rental equipment to the offshore and subsea industry.

We have experienced a steady growth in business with continuous positive feedback from our clients. Furthermore, our ambition is to expand on this growth

in the coming years, by increasing our client group and our variety of equipment. In accordance with our business plan and our extensive client group, we have not only invested in new equipment but also in more members of staff. This investment offers more choices to our clients and their operations. Additionally, we are able to develop our diverse industry network and further enhance our North Sea expertise.

We value our clients and our vision is to provide a positive experience for everyone we work with, as they put their trust in us. Therefore we are confident you will find this equipment list to suit your needs. We look forward to working with you on your next operation.

Email us today for more information: post@offshorerental.no

Buoyancy/Subsea Lifting Equipment

Air Lift Bags	04
Subsea Buoyancy Elements	04
Lifting Gear	05

Subsea Lifting Equipment & Positioning

ROV Shackles/Rov Hook	06
USBL Systems	07

Positioning & ROV Tools

Motion Sensors, Acoustic Telemetry	08
Torque Tools	09
Subsea Cutting Tools	10
Cleaning Tools, Hot Stabs	12
Manipulators, Hydraulic Impact Wrenches	13
Dredging & Excavation	14
ROV Skid, ROV Operated Drilling Tools	14
ROV Latch, Dredging & Excavation	14

ROV Sensors & Geophysical Equipment

Bathymetric & Profiling Systems	15
Pipe & Cable Tracking, Doppler Systems, Sonars, Navigation	16
Sub-Bottom Profiler	17
Side Scan Sonar, Magnetometers	17

Subsea Video Inspection

Subsea Video Cameras	18
Subsea Digital Stills Cameras	18
Subsea Video Zoom Cameras, Subsea Lasers	19
Subsea Lights, Mini ROVs	20
Camera Accessories, Camera Systems, Multiplexer	21

NDT & Inspection

Subsea MPI, Subsea Thickness Gauging	22
Corrosion Monitoring	23
Subsea Eddy Current	23

Gudewire Equipment

Guidewire Equipment	24
---------------------------	----

Subsea Lifting & Handling

Subsea Baskets	26
Overboarding Chutes, Winches, Containers	27

Buoyancy/Subsea Lifting Equipment

Air Lift Bags

1. Inflatable Buoyancy Units (IBU)

A Standard Range of Inflatable Buoyancy Units (IBU) for supporting static loads at any depth.

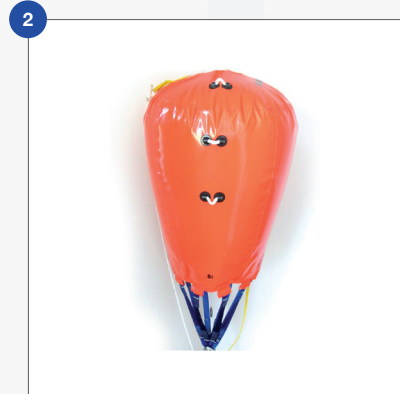
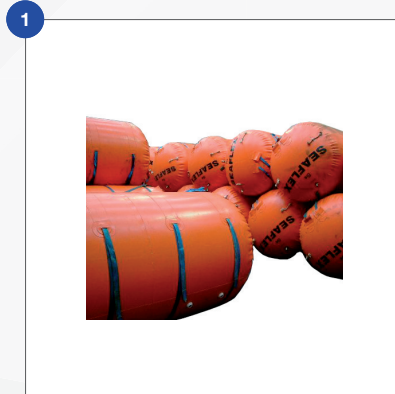

2. Air Lift Bags (ALB)

A Standard Range of Air Lift Bags (ALB) for supporting and lifting loads from any depth.

3. Air Hoses

NOR has a wide range of air hoses for air lift bags and other purposes.

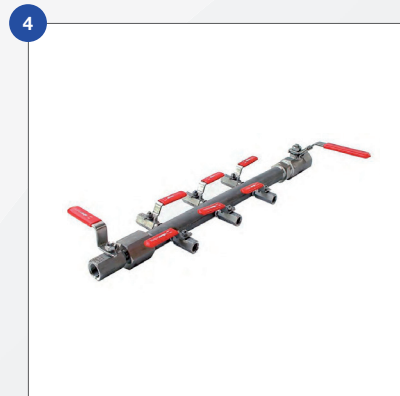

4. Manifolds

Manifolds to control the filling of air lift bags.

Subsea Buoyancy Elements

5. Spherical Buoys

The buoys are singlepiece devices, and suitable for operations and needs where buoyancy requirement are modest.

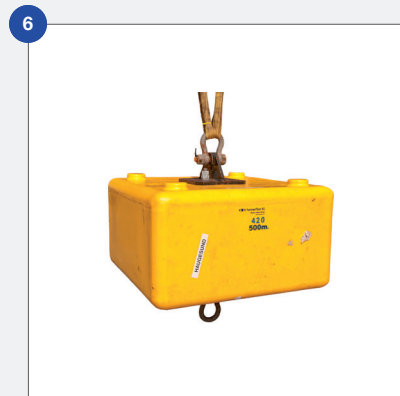

7. Subsea Support Buoy 200

The SSB200 consist of two module sizes and can be put together in a wide range of combinations.

Email us today for more information: post@offshorerental.no



7. Subsea Support Buoy 400

The SSB400 serie consists of two module sizes and can be put together in a wide range of combinations.

8. Subsea Support Buoy 850

The SSB850 serie is a mid-range buoy, and can be delivered with between one to five elements mounted together.



9. Subsea Support Buoy 850

The SSB850 serie is a mid-range buoy, and can be delivered with between one to five elements mounted together.

10. Modular Support Buoy 111

The MSB111 serie has two element types.

Lifting Gear



11. Soft Slings

NOR has a large inventory of soft slings available for hire

12. GP Shackles

GP Shackles ranging from 0.5t to 2,000t. Other types of shackles can be supplied upon request.

Subsea Lifting Equipment & Positioning

ROV Shackles/Rov Hook

13. Imenco ROV Shackle

The Imenco ROV Operated semi-automatic Shackle has rapidly established itself as the industry standard.

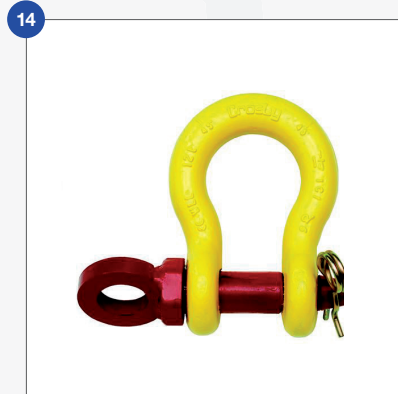

14. Crosby Rov Shackle

The Crosby G-209R Rov Shackle is delivered with capacities from 6.5Te to 55Te.

15. Triton Rov Hook

The safe and dependable remote operated hook for subsea use.

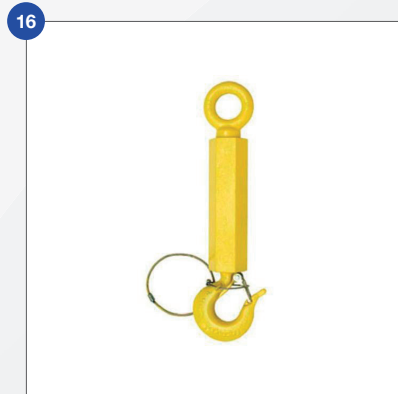
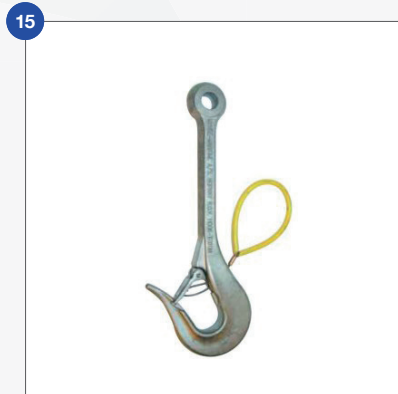

16. Rov Shank Hook

The ROV Shank Hooks have a long hexagonal body for easy handling by ROV manipulators and are opened remotely by pulling the retraction wire.

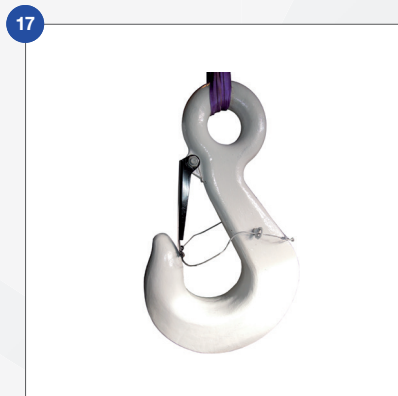

17. Rov Eye Hook

The ROV eye hooks are manufactured specifically for easy handling by ROV manipulators and are opened remotely by pulling the retraction wire. Available from 8t to 400t.

18. 400Te Rov Hook

The Rov Hook has a purpose-built safety latch and protection structure which ensures easy connection and release by ROV. It is also designed in a way that makes the lifting operation safe and efficient.

Email us today for more information: post@offshorerental.no

19



20



21



22



23

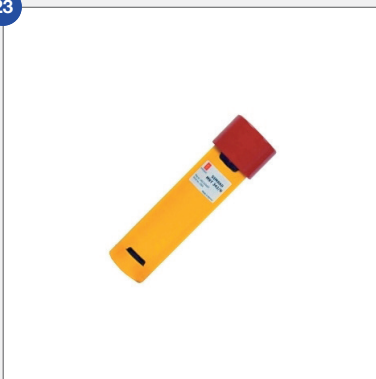

24



USBL Systems

19. Applied Acoustic 916 / 919 Mini Beacons

Mini Beacons are compatible with Easytrak and almost all industry tracking systems operating worldwide.

20. Applied Acoustic 219 Micro Beacons

Designed to provide a significantly lower cost solution to positioning in shallow water environments.

21. Kongsberg cNODE

Kongsberg cNODE® is a family of transponders for underwater acoustic positioning and communication.

22. MPT 319/DTR

The transponder models have 56 channels for use with the HiPAP / HPR systems.

23. Mini SSBL Transponders (MST)

The MST transponders are to be used with the Kongsberg Maritime underwater and positioning and navigation systems; the HiPAP system and the HPR series.

24. Ranger 2 acoustic positioning system

Ranger 2 is a survey grade Ultra-Short BaseLine (USBL) acoustic positioning system designed for deep water, long range tracking of underwater targets and position referencing for dynamically positioned vessels.

Positioning & ROV Tools

Motion Sensors

25. iXBlue Phins 6000

High performance subsea inertial navigation system for deep water. PHINS 6000 is a subsea inertial navigation system providing position, true heading, attitude, speed, depth and heave.

25



26



26. iXBlue Rovins

Rovins is a combined survey-grade full featured Inertial Navigation System (INS) for water depths up to 3000m.

27



28



27. iXBlue Octans 3000

Octans 3000 is a subsea survey-grade gyrocompass and complete motion sensor for water depths up to 3000m.

28. TSS ORION Subsea

Orion INS has been designed for the demanding hydrographic survey, offshore construction and ROV operations markets.

29. TSS DMS-05 MOTION SENSOR

Motion Measurement for Multibeam Echosounders.

29



30



Acoustic Telemetry

30. LinkQuest UWM 200H Underwater Acoustic Modem

With the innovative technologies, LinkQuest's modems have achieved significantly increased data rate (up to 38,400 baud),

Email us today for more information: post@offshorerental.no

31



32



33



34



35

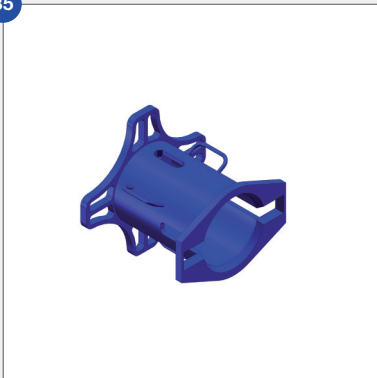

36



Torque Tools

31. Class 1-2 Torque Tool

This torque tool has been specifically developed to provide the highest level of performance.

32. Torque Tool, ISO 13628-8 Class 1-4 (API 17D)

This tool has integral torque and turns counting sensors for closed loop control.

33. 17kNm Torque Tool

Specifically developed to address the increasing requirement for a 17kNm Tool.

34. Class 1-4 Verification Unit

This unit is used to give pre-dive surface confirmation of the torque tool calibration.

35. Class 6/7 Verification Unit

This unit is used to give pre-dive surface confirmation of the torque tool calibration.

36. RCU – Torque Tool Control System

The Jupiter Torque Tool Control System offers an accurate and repeatable solution to client requirements for the control of Torque Tools in high integrity applications.

ROV Tools

37. Upright Flying Lead Orientation Tool (FLOT)

The FLOT tool is used to orientate and guide flying leads into the stab plate connections.

37

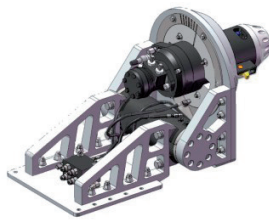

38

38. 17D to 17H Torque Tool Adapter

The torque tool adaptor is used to convert from ISO 13628-8 Class 4 (API 17D) to API 17H High Torque interface.

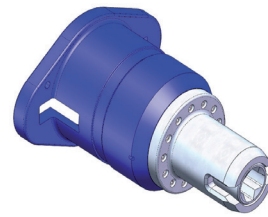

Subsea Cutting Tools

39. Wire Rope Cutter – 38mm

The webtool wire rope cutter WCOS38(D) is designed for cutting large diameter wire rope up to 38mm diameter in the most hostile environments.

39

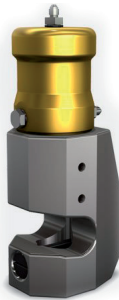

40

40. Wire Rope Cutter – 54mm

The webtool wire rope cutter WCOS54(D) is designed for cutting large diameter wire rope up to 54mm diameter in the most hostile environments.



41

41. Webtool wire cutter, RCV75HD

Cutting large diameter wire rope and cable in the most hostile environments under the toughest of conditions and the most demanding of circumstances requires something special.

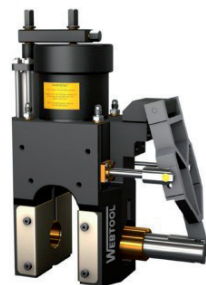

42

42. Webtool wire cutter RCV 115

Cutting large diameter wire rope and cable in the most hostile environments.

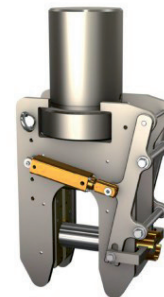

Email us today for more information: post@offshorerental.no

43



44

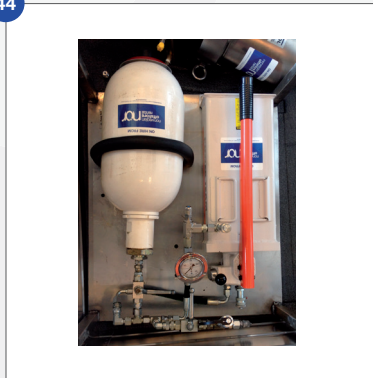

43. Webtool wire cutter RCV 115 w/lifting fram

115mm wire cutter with certified lifting frame and built-in intensifier and hot stab system.

44. Accumulator

Accumulator system for wire cutters. Typically used for emergency cutting.

45



46



45. Minibooster w/ hoses

In-Line Pressure Intensifier, 3.4 ratio. 680 bar max output pressure. Supplied with 4 x 4 meters hoses.

46. Enerpac Hand Pump

Enerpac hand pump 700bar two-way function w/ pressure gauge and pressure control valve.

47

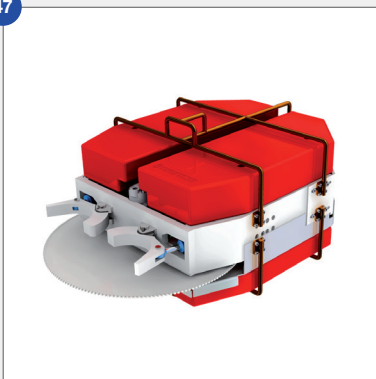

48



47. Mantis ROV Operated Saw

ROV operated saw for cutting chains, pipes or similar.

48. Versatile Super Grinder

The Versatile Super Grinder is designed for quick and efficient cutting of concrete and steel materials.

ROV Tools

Cleaning Tools

49. Multipurpose Cleaning Tool

The MCT uses a mild acid cleaning solution dispensed through the brush head.

50. ROV High Pressure System

The ROV High Pressure System is normally use for subsea cleaning.

49



50



Hot Stabs

51. Ø43 – ISO 13628-8 Hot Stab

A balanced connection can be connected and disconnected with full pressure.

52. Ø35 API 17D Hot Stab

A balanced connection can be connected and disconnected with full pressure.

53. Ø55 SP Stab 1000Bar

The Blue Logic Ø55 Hot Stab is designed for high flow and high pressure 1035 BAR 15 000 PSI

54. Dummy Hot Stabs

Dummy Hot Stabs in different sizes.

51



52



53



54

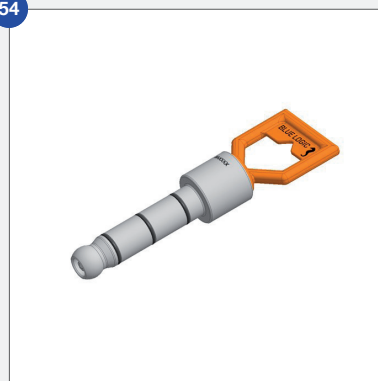

Email us today for more information: post@offshorerental.no

55



56



57



58



59



60



Manipulators

55. TITAN 4 Manipulator

The TITAN 4 is widely regarded as the world's premier servo-hydraulic remote manipulator system.

56. 3-finger Jaw

The Imenco 3-finger front adapter is made in high strength stainless steel and will make an exact fit to Schilling's Titan II III/IV and Orion manipulators.

57. 4 Finger Jaw Manipulator

The Imenco 4-finger front adapter is made in high strength stainless steel and will make an exact fit to Schilling's Titan II/III/IV and Orion manipulators.

58. ARM 5E Micro

5 function electrical manipulator – With a weight of only 2.8kg submerged, the manipulator can be used for small ROVs or as a tool itself. Require 24VDC and 1x RS232.

59. ARM 5E

5 function electrical manipulator - Light weight. Require 24VDC and 1x RS232

Hydraulic Impact Wrenches

60. Stanley IW12 Impact Wrench

The IW12 can handle a wide variety of applications.

ROV Tools & ROV Sensors

Dredging & Excavation

61. Tritech Super ZipJet

The all-new Super ZipJet replaces the successful Tritech ZipJet Ultra range of products.



62. DragFlow Electric Pump

Heavy Duty Electric submersible dredge pump.

ROV Skid

63. Fluid Injection Skid

Fluid Injection Skid7500 PSI is designed to be operated by standard WROV.

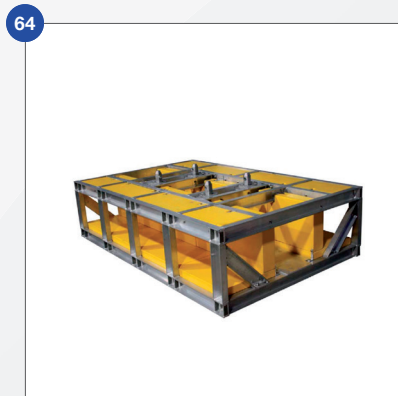
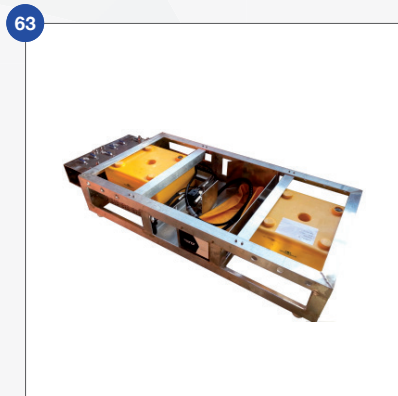

64. ROV Work Skids & Tool Deployment Units

ROV Operated Drilling Tools

65. ROV Operated Drilling Tool

The Imenco Stinger ROV Drilling Tool is a portable hydraulically operated drilling machine which can be operated by a work class ROV. It is designed for subsea drilling operations on a variety of applications and steel thicknesses.

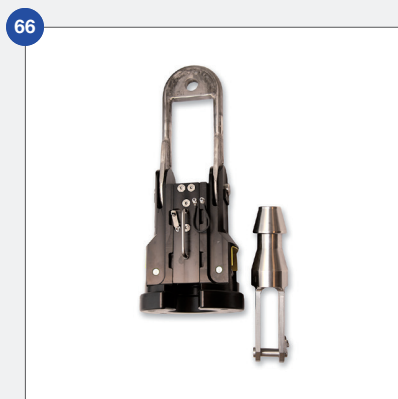

ROV Latch

66. ROV Latch

The Imenco latch will increase overall safety and ease deployment and recovery of small to medium sized ROV's

Email us today for more information: post@offshorerental.no

67



68



69



70



71



72



Bathymetric & Profiling Systems

67. Valeport miniIPS

The miniIPS is a precision underwater pressure sensor.

68. Tritech Multicomm Subset Junction Box

Versatile subsea connection for SeaKing and SeaPrince systems.

69. Tritech Super SeaKing DFP

The Super SeaKing Dual Frequency Profiler uses the latest technological advances available in transducer design.

70. Tritech SeaKing 704 Bathy

The SeaKing Bathymetric System operates as a stand-alone instrument, or a single subsea node on the SeaKing network and shares the same twisted pair wiring as the SeaKing Profiler or SeaKing Sonar.

71. Tritech SeaNet SCU V5

The SeaNet SCU V5 provides a reliable, rugged and easy to install replacement for the SCU V4.

72. Paroscientific Digiquartz

Digiquartz® Depth Sensors provide the ultimate precision in water level measurements.

ROV Sensors & Geophysical Equipment

Pipe & Cable Tracking

73. TSS 350 Cable Tracking System

With modern subsea cable systems becoming increasingly sophisticated and their deployment, recovery and repair a more exacting science.



74. TSS 440 Pipe Tracking System

TSS 440 utilises pulse induction technology and advanced digital signal processing to accurately determine ranges to buried pipelines or cables.



Doppler Systems

75. RDI Workhorse Navigator

The Workhorse Navigator is the industry's first choice for precision navigation applications.



Sonars

76. Tritech Micron DST

The smallest digital CHIRP sonar in the world.

Navigation

77. Tritech Micron Nav – USBL Tracking System

To be used in conjunction with the Tritech Micron / SeaSprite sonar and other Tritech Micro products.

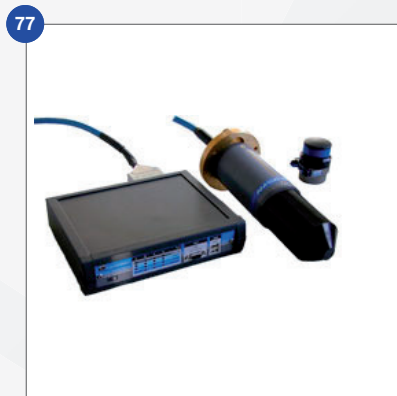

78. Toughbook CF-30

Panasonic Toughbook CF-30 PC with software for Tritech Micron DST Sonar and MicronNav.

Email us today for more information: post@offshorerental.no

79

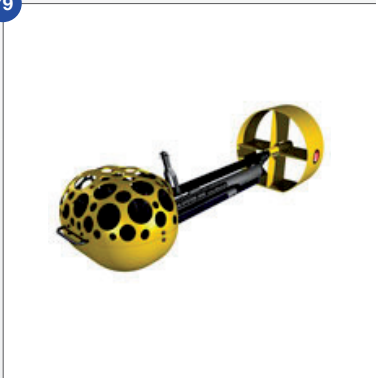

80

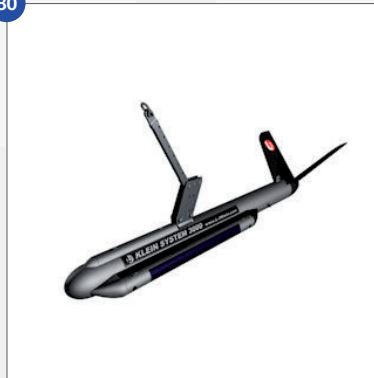

Sub-Bottom Profiler

79. Klein K-Chirp 3310 Sub-Bottom Profiler

The K-Chirp Model 3310 SPB is a "Chirp" sub bottom profiler attachment for the Model 3000 Side Scan Sonar.

Side Scan Sonar

80. Klein 3000 Digital Side Scan Sonar System

Klein Associates Inc.'s new System 3000 presents the latest in digital side scan technology and in digital side scan sonar imaging.

81



82



81. Klein Towfish Depressor

The K-WING DEPRESSOR mounts between the towfish and the tow cable. It develops a strong hydrodynamic force driving the towfish and cable down.

Magnetometers

83

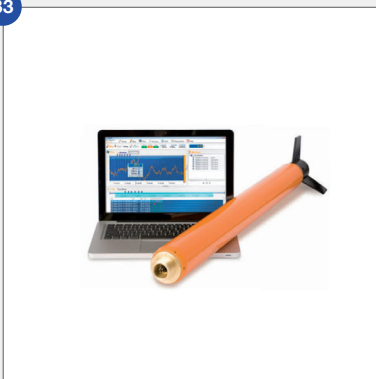

84

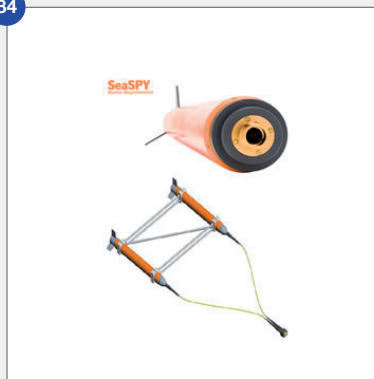

82. Geometrics G882 Marine Caesium Vapour Magnetometer

Very high resolution Cesium Vapour performance is now available in a low cost, small size system for professional surveys in shallow or deep water.

83. Marine Magnetism Explorer Mini Magnetometer 300m

Explorer's light weight, compact size and ultra low power consumption make it the ideal tool for shallow water surveys, especially when deployed from a small craft.

84. Marine Magnetism Sea Spy Magnetometer 1000 mW

Subsea Video Inspection

Subsea Video Cameras

85. Basking Shark Camera, Low Light

Low light camera for use on large ROV systems and small observation systems.

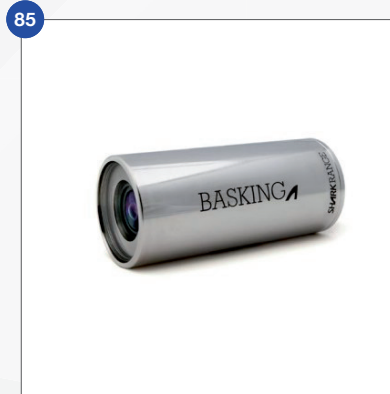

86. Silvertip Shark Camera with LED light

The Silvertip is a small user friendly camera, with LED lights, high quality colour video and up to 90 angel of view.



87. Greytip Shark Camera

The Greytip is a popular small size colour camera often chosen by ROV and diving operators.

88. Mako Shark Camera

The Mako camera is perfect as a tool or inspection camera due to its size and weight and can also be used as a diver's camera.

Subsea Digital Stills Cameras

89. Tiger Shark Camera, Digital Stills

The Tiger Shark is a digital stills camera perfect for ROV use or as a high resolution stand-alone camera for research purposes.

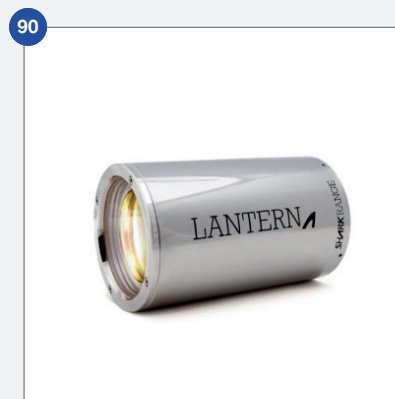

90. Lantern Shark – Flash

The Lantern is a high output flash for the Tiger digital stills camera and will facilitate high quality images at distances up to 7 – 10m. This makes it ideal when capturing remote objects.

Email us today for more information: post@offshorerental.no

91



92



93



94



95



96



Subsea Video Zoom Cameras

91. Lizard Shark Pan/Tilt Camera

ROV Pan, Tilt, Zoom inspection Colour Video with built in LED lights. Versatile subsea inspection zoom colour camera for ROV use in confined areas down to 1000 MSV.

92. Bull Shark Camera – HD-SDI

The bull is a high definition (HD-SDI) camera, ideal when operators need high quality zoom capabilities combined with excellent resolution.

93. Hammerhead Shark Camera

18xzoom. The Hammerhead wide angle colour zoom camera is used as main camera on work class ROVs.

94. Whitetip Shark Camera

10x Zoom and LED light. The Whitetip is a colour zoom camera with dimmable LED's and often used as a tool camera for close up inspections where illumination is needed.

Subsea Lasers

95. Dusky Shark – 30mW Line Laser

The Dusky laser is a green line laser used when measurements are needed from video images.

96. Angel Shark, 150mW Line Laser

The Angel laser is a powerful green line laser used when measurements are needed from video images.

Subsea Video Inspection

Subsea Lights

97. SeaLED 20

The SeaLED 20 miniature high output light for divers/small ROV/tools and inspection points.



98. SeaLED 65

The SeaLED 65 is a high output multi purpose light for ROV/tools and inspection points. Fitted with the latest high quality LED producing a increased lifespan compared to the traditional Halogen and HID lights.

99. SeaLED 125

The SeaLED 125 is a high output multi purpose light panel for ROV and inspection points.

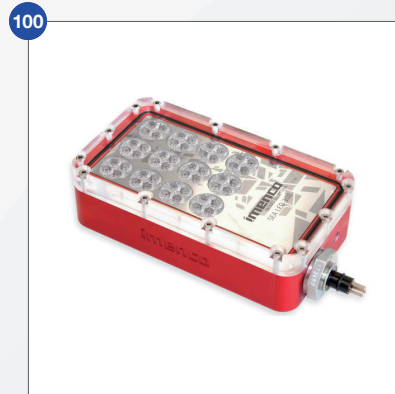
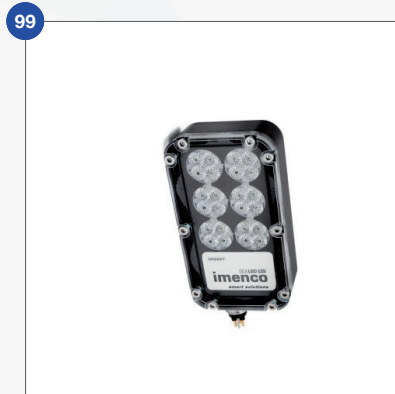

100. SeaLED 300

The SeaLED 300 is a high output multi purpose light panel for ROV and inspection points.

Mini ROVs

101. LBV 200-4

The SeaBotix LBV200-4 has become the benchmark MiniROV. An incredibly well-rounded and capable system for a diverse range of applications.

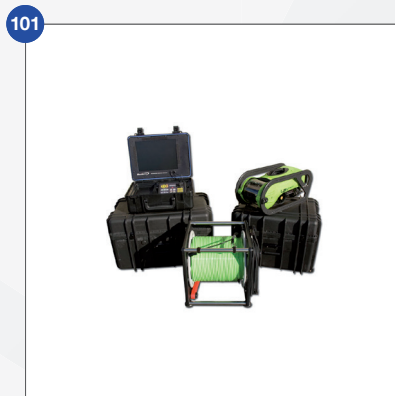

102. LBV 300-5

The SeaBotix LBV300-5 is the ultimate in versatility for a wide range of applications including maritime security.



Email us today for more information: post@offshorerental.no

103



104

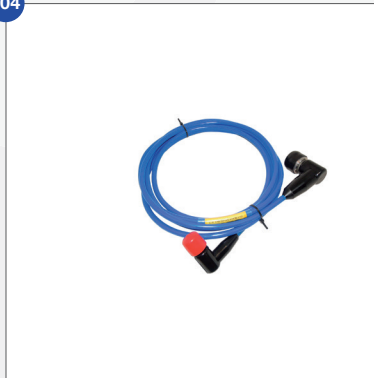

105



106



107

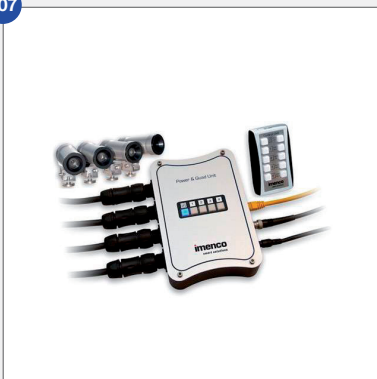

108

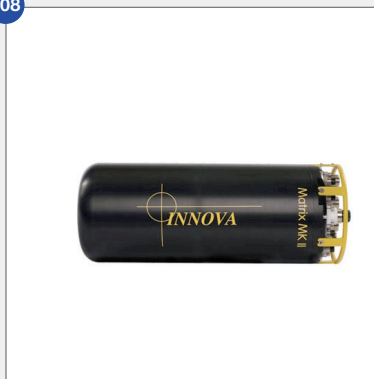

Camera Accessories

103. Extension kit for Lizard Shark Pan and Tilt Camera

The kit includes ROV handle, flexi joint, extension arm and protection sleeve.

104. Subsea Cables

Subsea cables for all cameras, lasers, etc are available for hire.

Camera Systems

105. 4 channel Video Recorder w/overlay

106. VisualDVR

VisualDVR is a 4U rack-mountable digital video recorder specifically designed for the offshore survey, inspection and ROV market

107. Imenco Quad CCTV system

The system is set with four waterproof cameras with the Power & Quad unit as the heart of the system

Multiplexer

108. Multiplexer Matrix MK II

The Matrix MK II is a stand-alone fibre optic multiplexer and control solution, providing a simple, plug-and play interface for a large array of sensors and equipment to any remotely operated system.

NDT & Inspection

Subsea MPI

109. ASAMS System 3 MPI

The ASAMS MPI Mk3 System is a modular design employing a sophisticated power control Surface Unit and an integrated, pressure compensated, Subsea Unit with built-in ink management systems.

109



110



110. ASAMS System 12 Underwater MPI System

Underwater MPI System has been developed as the ideal diver operated underwater MPI system for shallow water/tidal water use.

111



112



111. CYGNUS M5 ROV

Available in two models: M5-ROV-2K 2000m (6,526 ft) depth rated and M5-ROV-4K 4000m (13,123ft) depth rated.

112. Howard Chambers Dual Subsea Light Meter

This instrumentation package is designed to enhance the integrity of sub-sea MPI.

113



114

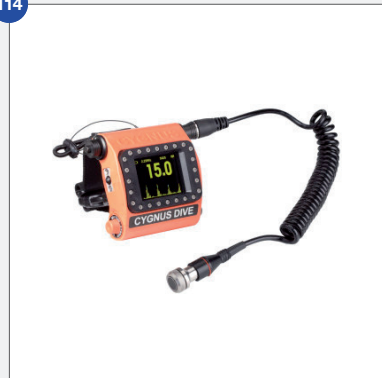

Subsea Thickness Gauging

113. CYGNUS M5 ROV

Available in two models: M5-ROV-2K 2000m (6,526 ft) depth rated and M5-ROV-4K 4000m (13,123ft) depth rated.

114. CYGNYS Dive

The latest innovation from the pioneers of the digital multiple echo ultrasonic thickness gauge, the Cygnus DIVE is designed for the professional diver and is accurate, reliable and easy to use.

Email us today for more information: post@offshorerental.no

115



116



117



118



119



120



Corrosion Monitoring

115. H4-UCPI4 Contact Probe

A lightweight and versatile instrument that provides a means of carrying out cathodic protection potential measurements.

116. H5 – UCP1B Proximity Probe

The UCP1B Proximity Probe is a versatile instrument for conducting underwater cathodic protection potential measurements.

117. Buckleys Bathycorrometer

The Bathycorrometer® is an advanced, hand held, diver operated unit providing a consistent way of determining the corrosion of subsea structures.

118. Bukleys Marine Survey Kit

The Marine Survey Kit comprises a Weighted Silver/Silver Chloride Half Cell, plastic cable spool and an accurate multimeter.

119. Versatrax 100 Micromag

The MicroMag™ mobile robotic inspection vehicle is compact, waterproof and magnetic. It can be rapidly deployed for many applications that exclude most ordinary ROV's.

Subsea Eddy Current

120. Phase C3 Eddy Current Flaw Detectors

The Phase 3 offers full phase plane functionality in an ultra-compact package

Guidewire Equipment

Guidewire Equipment

121. Wepeco Guidewire Anchor

ROV operated anchor from Wepeco for efficient subsea connection of guidewires.

121



122



122. Wepeco Lifting Anchor

The ROV-operated lifting anchor is specially designed for lifting of guide-posts.

123. Imenco Guidewire Anchor – Standard

The Slim Line anchor offers an added feature as the anchor allows full entering into the guide post.

123



124



124. Imenco Guidewire Anchor – Standard with Safety Sleeve

The Imenco Guidewire Anchor with safety sleeve is a further developed version of the standard Imenco Guidewire Anchor. This version offers added security against unplanned release due to its safety sleeve.

125. Imenco Guidewire Anchor – Slim Line

This version offers added security against unplanned release due to its safety sleeve.

125



126



126. Imenco Guidewire Anchor – Slim Line with Safety Sleeve

This version offers added security against unplanned release due to its safety sleeve.

Email us today for more information: post@offshorerental.no

127



127. Imenco Guidewire Anchor Lifting Type

The Imenco Lifting Anchor is a guidewire anchor especially developed for lifting operations.

128



128. Imenco Guide Post Extension

The Imenco guide posts extension model M4-L are made from high strength stainless steel and outer pipe in carbon steel.

129



129. Imenco Top release Guide Post

Manufactured and used for close to 24 years and is known in the subsea market for its ease of use and dependability.

130

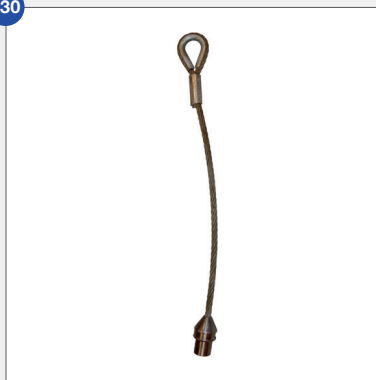

130. Forerunner wire

Forerunner wires potted in guidewire anchor tops. Lengths from 1m to 50m.

131



131. Guidewire anchor receptacle

Female connectors for guidewire anchors.

132

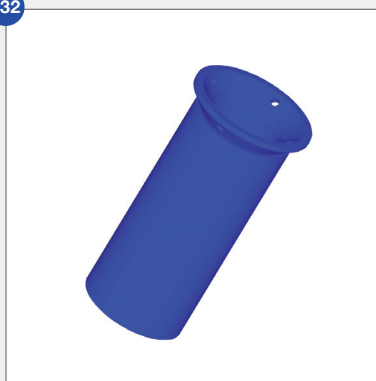

132. Guidepost receptacles

Receptacles for guideposts can be supplied as standard or based on customer requirements.

Subsea Lifting & Handling

Subsea Baskets

133. 4Te Subsea Basket

Multipurpose Subsea basket certified according to DNV 2.7.3. Payload capacity 4.000 kg.

133



134

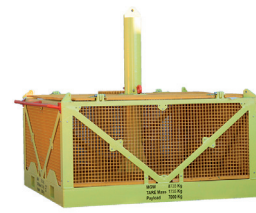

134. 7Te Subsea Basket

Multipurpose Subsea basket certified according to DNV 2.7.3. Payload capacity 7.000 kg.

135. 5Te Subsea Basket

1.7 meters length, 1.7 meters width. Payload capacity 5.000 kg.

135



136

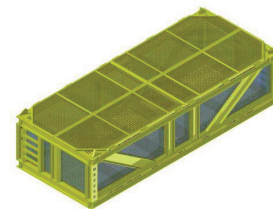

136. 8Te Subsea Basket

6.1 meters length, 2.4 meters width. Payload capacity 8.000 kg.

137. 15Te Subsea Basket

10.5 meters length, 2.6 meters width. Payload capacity 15.000 kg.

137



138

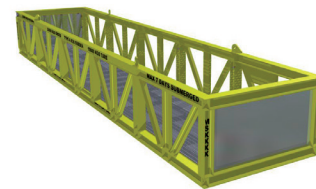

138. 23Te Subsea Basket

13.4 meters length, 2.8 meters width. Payload capacity 23.000 kg.

Email us today for more information: post@offshorerental.no

139



140



Overboarding Chutes

139. Overboarding chute WLL 1500 kg

Chute to transit cables, umbilical, etc. 1000mm bend radius.

140. Overboarding chute

Chute to transit cables, umbilical, etc. 1200mm bend radius.

141



142



Winches

141. Man Rider Winch, 1.5Te SWL

Ingersoll Rand's offering of dedicated and dual purpose (utility & personal lifting) Man Rider™ winches are known worldwide as the standard for meeting the toughest personnel lifting requirements in the industry.

142. 20T Winch

20 Tonne WLL Hydraulic Winch. Built to be transportable, robust and suitable for harsh marine environments.

143



144



Containers

143. 10 ft half height container

10 ft half height container w/ removable door. Can be supplied with ramp for fork lift.

144. 20 ft workshop container

The container is approved for work in Zone 2.

Norwegian Offshore Rental AS
PO box 2143
5504 Haugesund, Norway

Office address:
Stoltenberggt. 1
5527 Haugesund
Norway

Olafur Gislason
Managing Director
Mob: +47 488 51 428
Email: og@offshorerental.no

Bjørn Kalland
Sales Manager
Mob: +47 995 00 421
Email: bk@offshorerental.no

Jan Sigurd Østebøvik
Business Development Manager
Mob: +47 915 50 054
Email: jso@offshorerental.no

Åsmund Våge
Equipment Manager
Mob: +47 959 06 823
Email: av@offshorerental.no

Nils Rune Hansson
Equipment Manager Survey
Mob: + 47 959 18 593

Call us today for more information on + 47 995 00 421 or email post@offshorerental.no